

DESIGN OF ARC LEAP-FROG FILTERS

Lubomír Fröhlich

Doctoral Degree Programme (4), FEEC BUT

E-mail: xfrohl00@stud.feec.vutbr.cz

Supervised by: Jiří Sedláček

E-mail: sedlacj@feec.vutbr.cz

Abstract: The sphere concerning frequency filters is constantly developing and there are many principles of non-cascade realizations which can be used for the design of *ARC* filters. Unfortunately, due to a very difficult design of the certain types of filter synthesis methods these filter realizations are not properly described and there is no detailed description of their usage in practice. One of these realizations is the *Leap-Frog* filter synthesis method. The article describes the method of the filter design of *ARC* filters growing from the connection of the *RLC* filters with *T* or *II* configuration. This method of the design has apart from very difficult design and bigger amount of active elements few considerable advantages, for instance very small filter sensitivity and excellent dynamic qualities.

Keywords: *Leap-Frog*, signal flow graph, dynamical ratios, *RLC* filter, *ARC* filter

1. INTRODUCTION

The *Leap-Frog* method of filter synthesis is leading to non-cascade filter block connections. Circuit structure of *ARC* filters created with the help of *Leap-Frog* combines the method of cascade block realization and realization growing from ladder *RLC* filters.

The principle of realization is based on the transfer of qualities of impedance coupled elements of ladder *RLC* filters to equivalently reacting connection with impedance distinguished *ARC* blocks of 1st order or 2nd order. The transformation on the resulting *ARC* circuit is realized according voltage and current ratio of the ladder *RLC* filter. These ratios are simulated by dyad of voltage relations. Integral or differential relations between current and voltage on inductors or capacitors are simulated by integrators which can be made by *OA* with capacitor in feedback [1].

If we want to design a circuit with the help of this method, there are several possibilities. The easiest one may be the use of description of original *RLC* circuit with the help of signal flow graph and their following transfer to the block structure with integrators. The easiest structures with integrators are defined crosswise connected capacitor or lengthwise connected inductor. Conversely, the most difficult structures are defined with crosswise connected of parallel combination or crosswise series of combination of inductor or capacitor.

This method is ideal by filter realizations with area of switching capacitors and their following usage in integrated circuits as filters realizing *LP*, *HP*, *BP*, *BR*, *LPN* and *HPN* filters with either configurations *T* or *II*.

2. THE SYNTHESIS OF LEAP-FROG FILTERS

For defining of complete design and detecting individual qualities and parameters it is enough to design *ARC* circuits for the lowest possible order of filter. Thus for *LP* and *HP* it is suitable to realize 2nd and 3rd order and for *BP* and *BR* of 4th and 6th order for the filter configuration in form *II* and *T*. With the help of these designs it is obvious in which situations it is necessary to add other sum-

mation of current to the circuit, with what number of OA we have to count, detection of dynamic qualities or spread of building elements, sensitivity, etc.

As an example for this article can be presented two filters design of 3rd order LP filter in T and Π configuration for input parameters $F_M = 10$ kHz, $F_P = 15$ kHz, $K_{ZVL} = -3$ dB a $K_{POT} = -15$ dB with *Tchebyshev* approximation. In the Fig. 1 and Fig. 2, there are connections of RLC filters with the division of elements for creating of formulas.

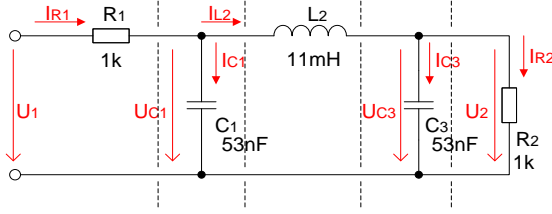

Figure 1: LP filter in Π configuration.

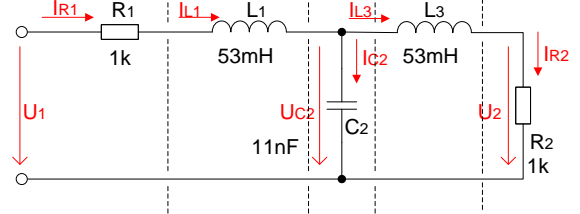

Figure 2: LP filter in T configuration.

For creation of signal flow graphs we have to set circuit formulas for individual elements, see (1), (2), (3), (4) and (5) for Π configuration and formulas for T configuration, see (6), (7), (8), (9) and (10):

$$I_{R1} = \frac{U_{R1}}{R_1} = \frac{U_1 - U_{C1}}{R_1} \quad (1)$$

$$I_{R1} = \frac{U_{R1}}{R_1} = \frac{U_1 - U_{C2} - U_{L1}}{R_1} \quad (6)$$

$$U_{C1} = \frac{I_{C1}}{pC_1} = \frac{I_{R1} - I_{L2}}{pC_1} \quad (2)$$

$$I_{L1} = \frac{U_{L1}}{pL_1} = \frac{U_1 - U_{R1} - U_{C2}}{pL_1} \quad (7)$$

$$I_{L2} = \frac{U_{L2}}{pL_2} = \frac{U_{C1} - U_{C3}}{pL_2} \quad (3)$$

$$U_{C2} = \frac{I_{C2}}{pC_2} = \frac{I_{L1} - I_{L3}}{pC_2} \quad (8)$$

$$U_{C3} = \frac{I_{C3}}{pC_3} = \frac{I_{L2} - I_{R2}}{pC_3} \quad (4)$$

$$I_{L3} = \frac{U_{L3}}{pL_3} = \frac{U_{C2} - U_2}{pL_3} \quad (9)$$

$$I_{R2} = \frac{U_{R2}}{R_2} = \frac{U_2}{R_2} \quad (5)$$

$$I_{R2} = \frac{U_{R2}}{R_2} = \frac{U_2}{R_2} \quad (10)$$

According to the set of formulas above it is not a problem to realize formulation of individual elements of RLC circuits with the help of signal flow graphs, see Fig. 3 and Fig. 4. It is obvious that in signal flow graph some changes are realized with the red color due to final connection of blocks.

For signal flow graph (see Fig. 3) is necessary to exchange the formulas (2) – (4), so that formula was multiplied by the value -1. For signal flow graph (see Fig. 4) it was necessary to add other two summations of current between I_{R1} and $-I_{L1}$, I_{L3} and $-I_{R2}$ which lead to the increase of number of OA in the circuit for two. It was also necessary to adjust the formula (7), (8) and (10) due to the polarity of currents and voltage and their connection, multiplying whole formula by the value -1.

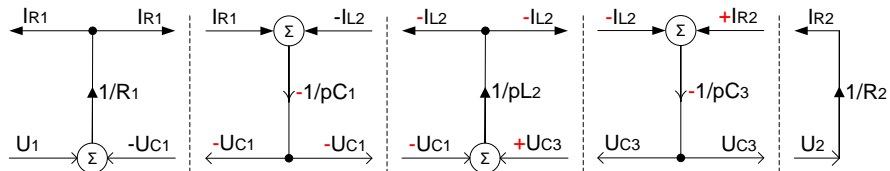

Figure 3: Basic signal flow graph for RLC filter in Π configuration.

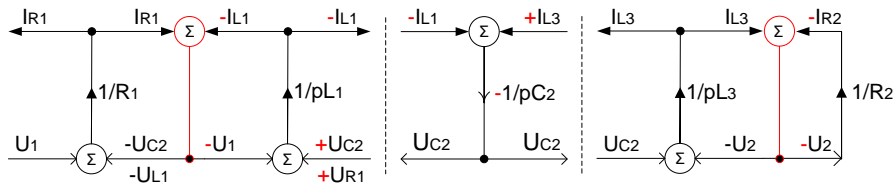

Figure 4: Basic signal flow graph for *RLC* filter in *T* configuration.

For creating of final signal flow graphs see Fig. 5 and Fig. 6 and then the whole *ARC* realization with the help of available integrator it is necessary to transfer current node $-I_{L2}$ and $-I_{L1}$ a I_{L3} to voltage with the help of multiplying of current and voltage chosen by regulating resistor R_N . After this modification we get $-U_{IL1} = (R_N^2 / pL_1)I_{UL1}$. The same modification can be applied also for others node $-I_{L2}$ and I_{L3} .

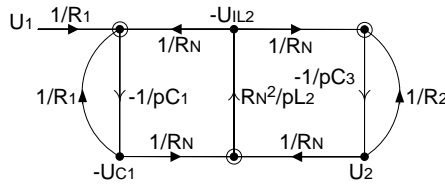

Figure 5: Final signal flow graph for *RLC* filter in *II* configuration.

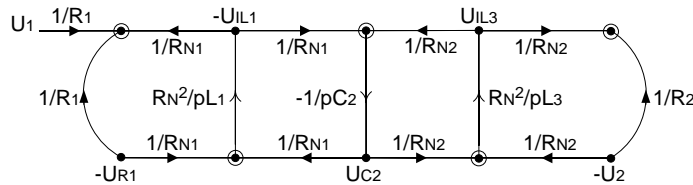

Figure 6: Final signal flow graph for *RLC* filter in *T* configuration.

With the help of final signal flow graph it is not problematic to set resulting *ARC* circuit (see Fig. 7 and Fig. 8). In the resulting circuit of *ARC* filters the realization of the coil is obvious with the help of two *OAs* and capacitors with the help of one *OA*. Thus it is obvious that *LP* with *II* configuration must be much easier than *LP* with *T* configuration. On the one hand, due to realization only on coil of the circuit. But on the other hand also due to unadding additional current summation. As it is in our case, due to series connection of the certain element with loading resistors.

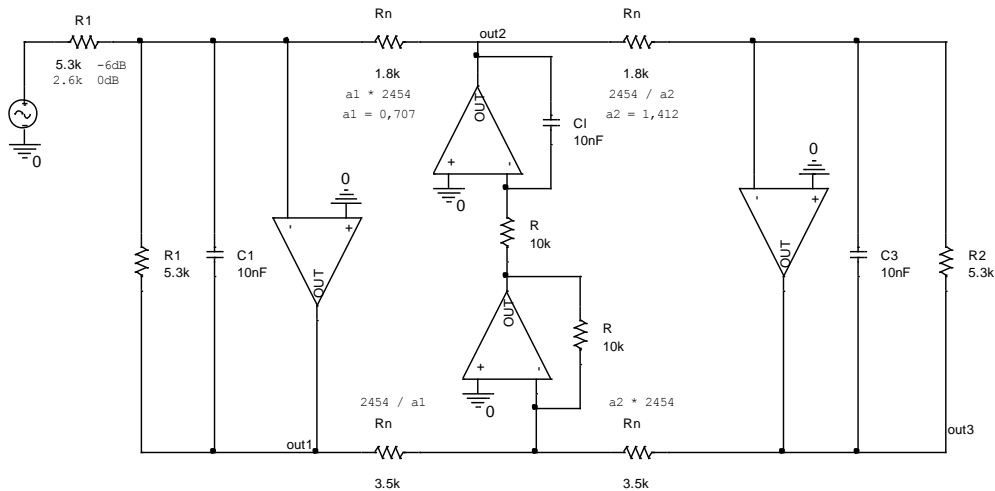

Figure 7: *ARC* filter with integrators and description of possible design of dynamical ratios in the circuit for *LP* with *II* configuration.

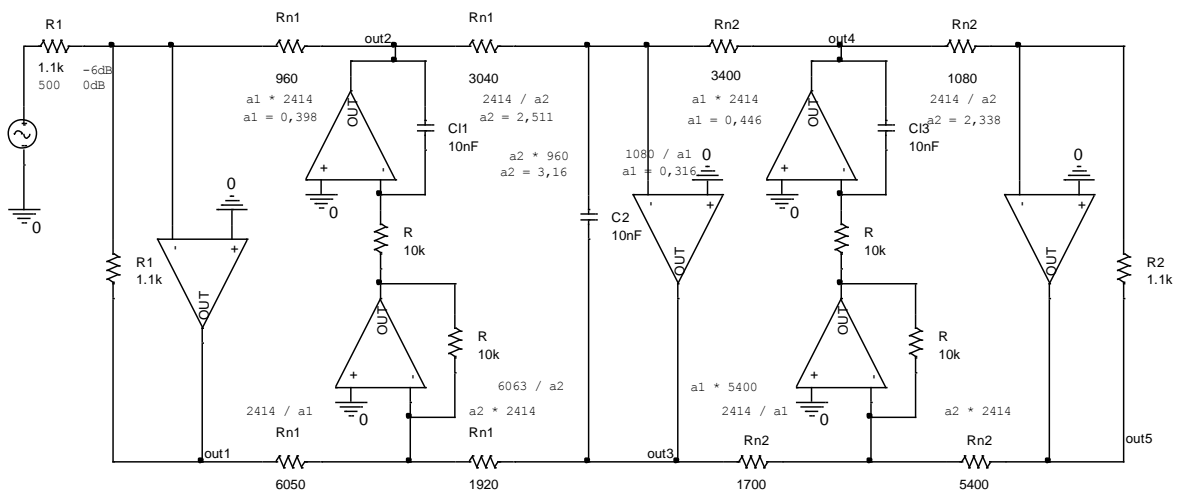

Figure 8: ARC filter with integrators and description of possible design of dynamical ratios in the circuit for LP with T configuration.

The biggest advantage of these connections is the possibility of compensation of scatter of building elements mainly capacitors due to re-counting of original RLC circuit. Due to this re-counting so that the value of capacitors will be 10 nF and option of the value of capacitors C_1 , C_{II} and C_{I3} to the same value, there is a spread of element value $k_C = 1$ and $k_R = 5,5$ for Π configuration and $k_C = 1$ and $k_R = 10,4$ for T configuration. The option of the value $k_C = 1$ is problematic mainly for BP and BR by the T filter configuration by choice the option of approximation with the zero transfer. In ARC connection there are certain modifications of regulation resistor R_N . These modifications are caused by dynamical modifications in the circuit so that maximum transfer on the individual outputs was the most consistent. The principle is realized so that the direct way from input to output is multiplying by constant a_1 - decay and after that divided by constant a_2 - gain. In the second part we will divide by constant a_1 and after that multiply by constant a_2 . Thus all maxims will be in acceptable extent and the circuit gains the excellent dynamics. The example of simulating of ARC filter due to verification of dynamical ratios (see Fig. 9). Inside the next Fig. 10 there is real measuring of ARC filters and their simulations.

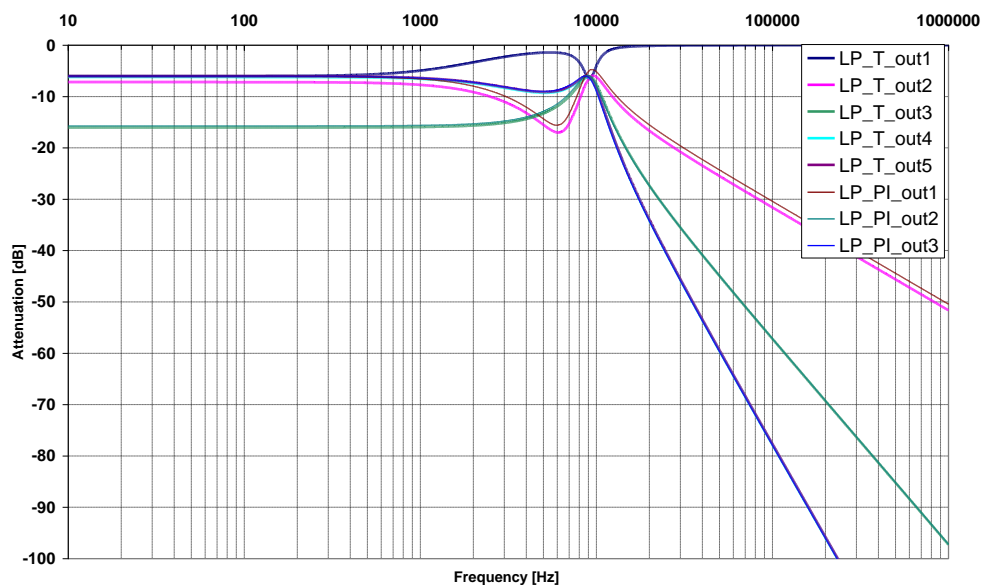

Figure 9: Simulation of dynamical ratios for both filters.

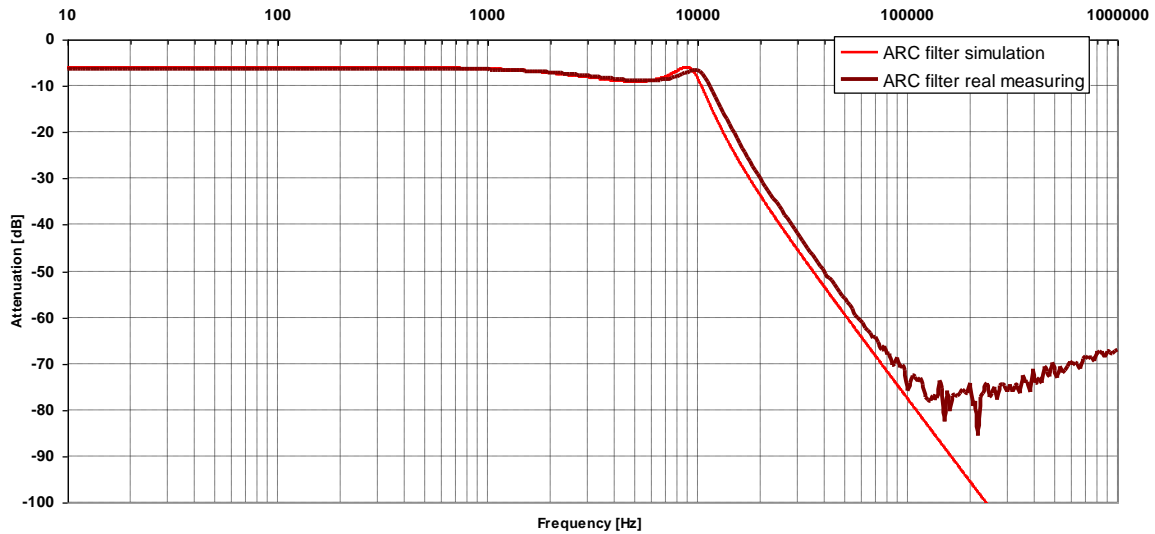

Figure 10: Real measuring and simulation of ARC Leap-Frog filters.

Table 1 represents maximum values of OAs in the circuits designed by this method.

Order of filter		2	3	4	5	6	7	8	9	10
Number of OAs	Π	4	4	7	7	10	10	13	13	16
	T	4	7	7	10	10	13	13	16	16

Table 1: Overview of the number of OAs for LP filter.

3. CONCLUSION

To sum up, it can be said that even despite the difficulty with the design it is possible to design certain circuits with the help of this method. Mainly, this will include LP and BP filters which contain acceptable number of OAs , on the contrary with BR or HP filters which have a big number of OAs in the circuit. For the use of LP or BP filters it is supported by the small spread of the building elements and the possibility of design of the capacity values in tolerance orders $E6$ or $E12$. Except for this, these circuits represent the smallest sensitivities and excellent dynamical ratios. To conclude, it can be claimed that these filters are the most suitable to use in integrated circuits with the help of switching capacitors.

REFERENCES

- [1] SEDLÁČEK, J.; K. HÁJEK, “*Kmitočtové filtry*,” 1. vydání, Praha : BEN - technická literatura, 2002, 535, ISBN 80-7300-023-7.
- [2] Dimopoulos, H. G. and A. G. Constantinidis, “*Linear transformation active filters*,” IEEE Trans, CAS, Vol. 25, No. 10, 845 - 852, 1978.
- [3] Ghauri, M. S. and K. R. Laker, “*Modern Filter Design*,” Practice Hall, New Persey, 1981.
- [4] Kapustin, V. I., “*Aktivnye RC - filtry Vyskovo Porjadka*,” Radio i svjaz, Moskva, 1985.
- [5] Sedra, A. and K. Martin, “*Design of signal - flow graph (SFG) active filters*,” IEEE Trans. CAS, Vol. 25, No. 4, 185 - 195, 1978.
- [6] Fröhlich, L.; Sedláček, J.; Friedl, M., “*Design of ARC filters by Leap-Frog method*,” Progress in electromagnetic 2012, Kuala Lumpur, www.piers.org, 2012.